

**IMAGES CREATED BY SPECSYS ON 02/28/2023.
TROMMEL TARP SYSTEM IS PRELIMINARY DESIGN.**

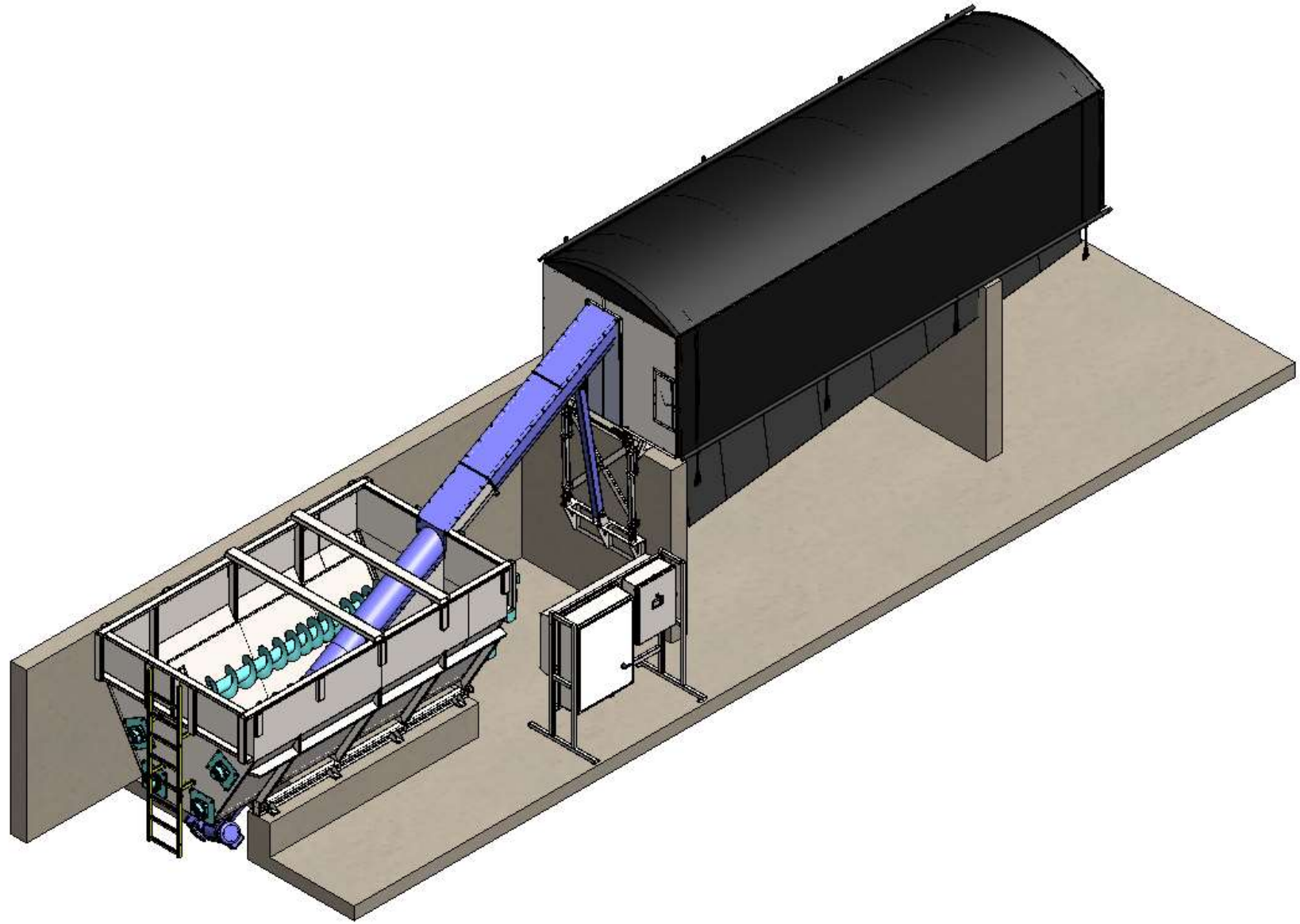

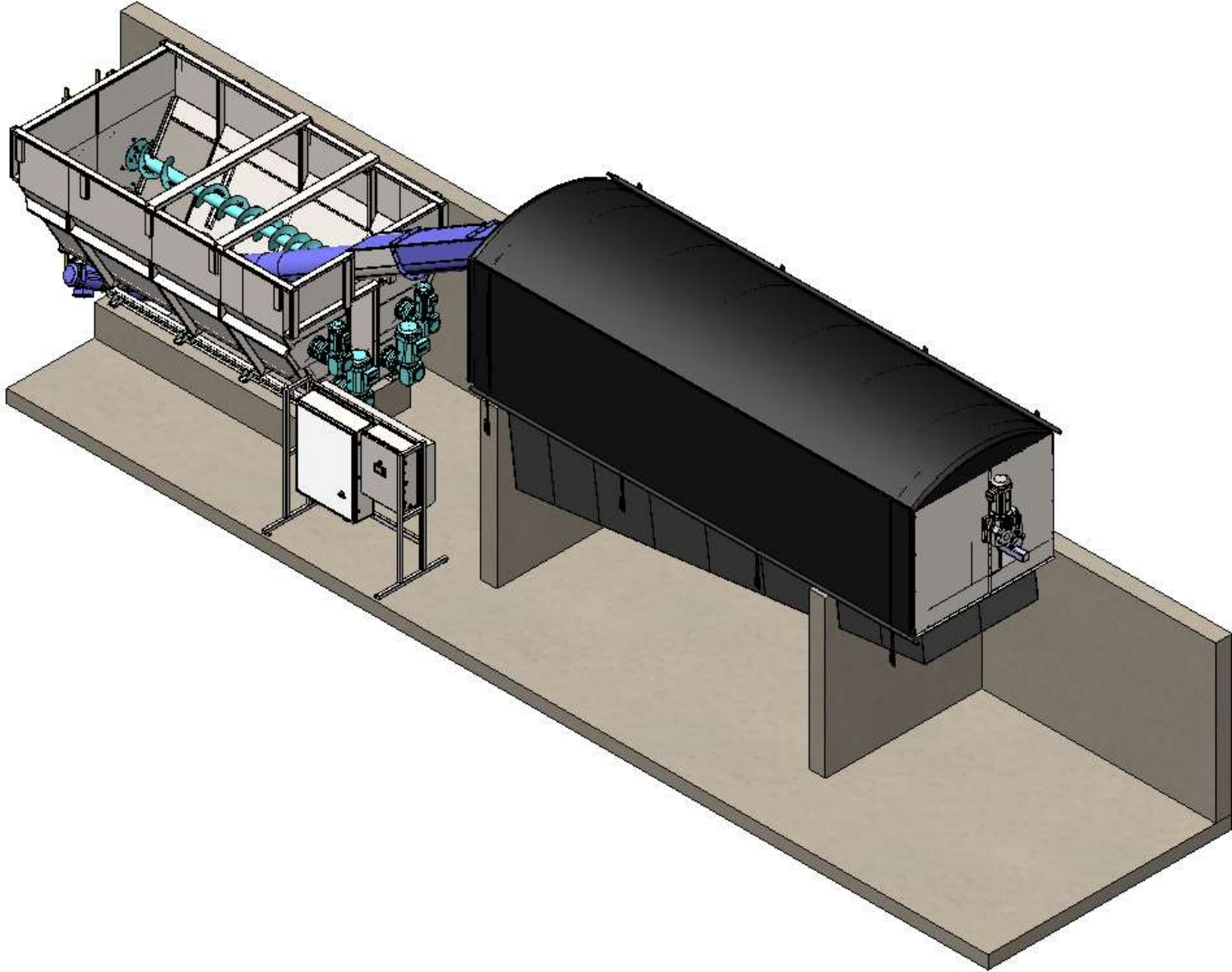

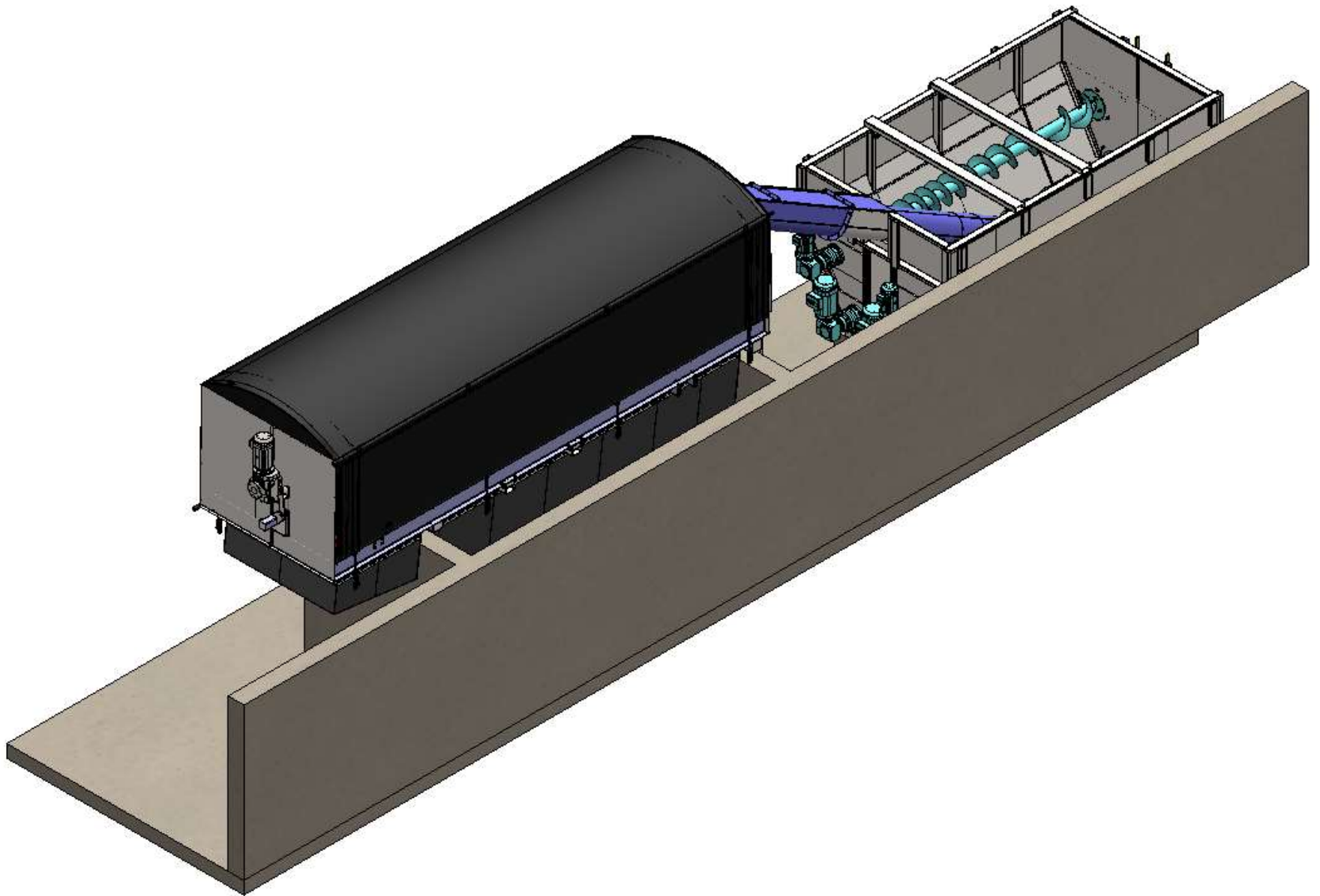

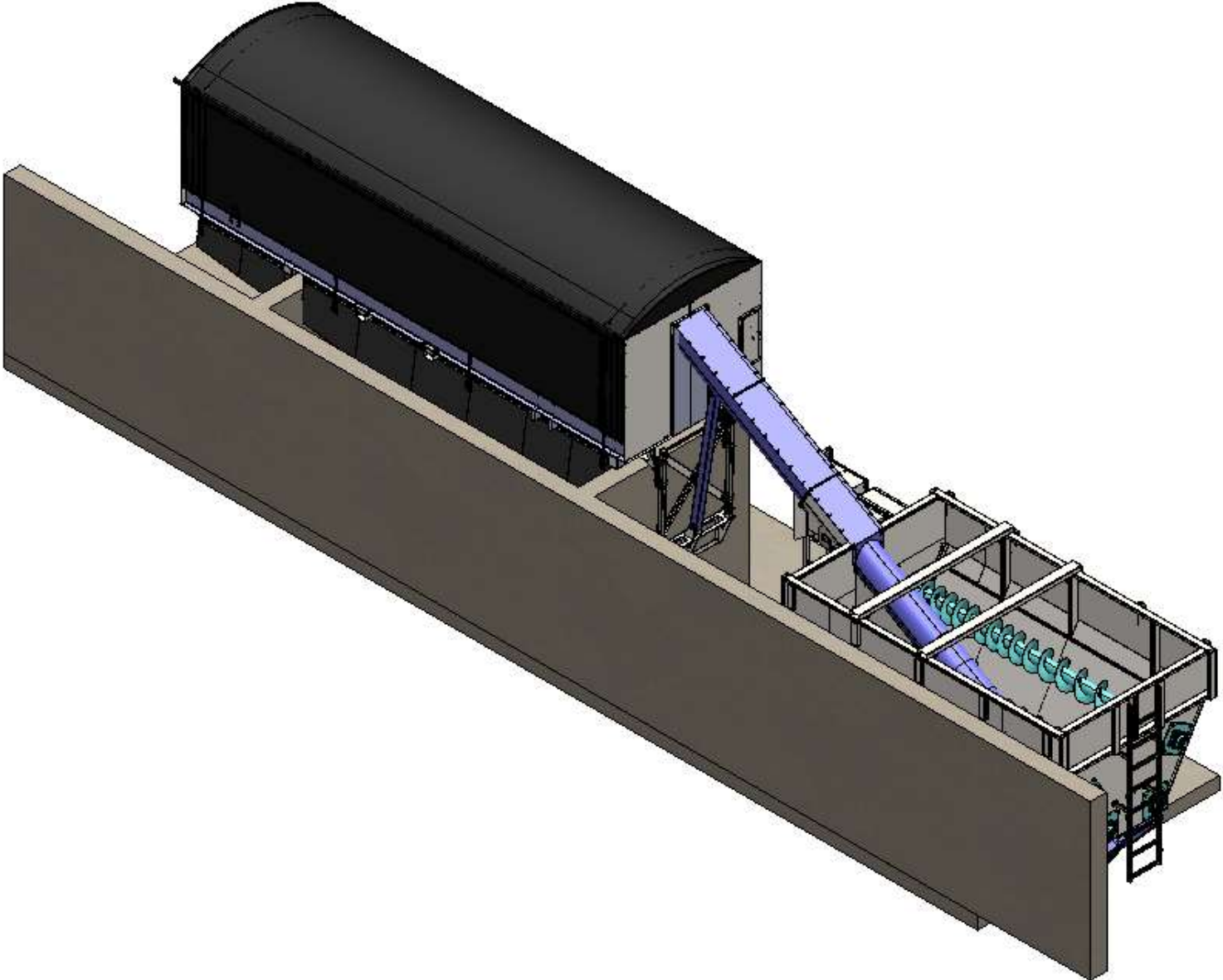

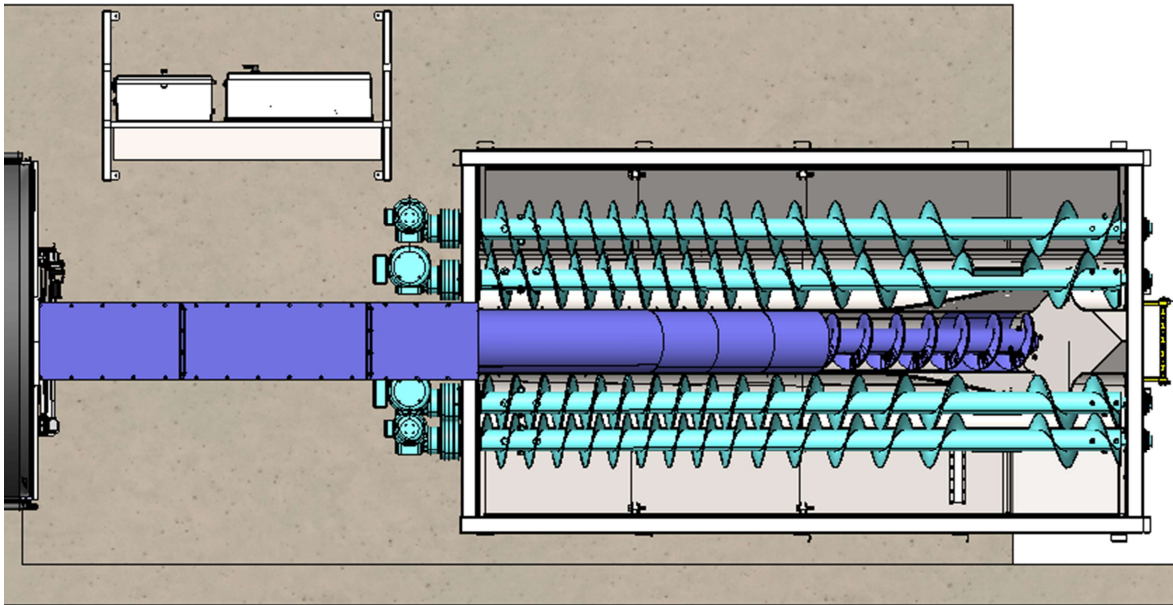
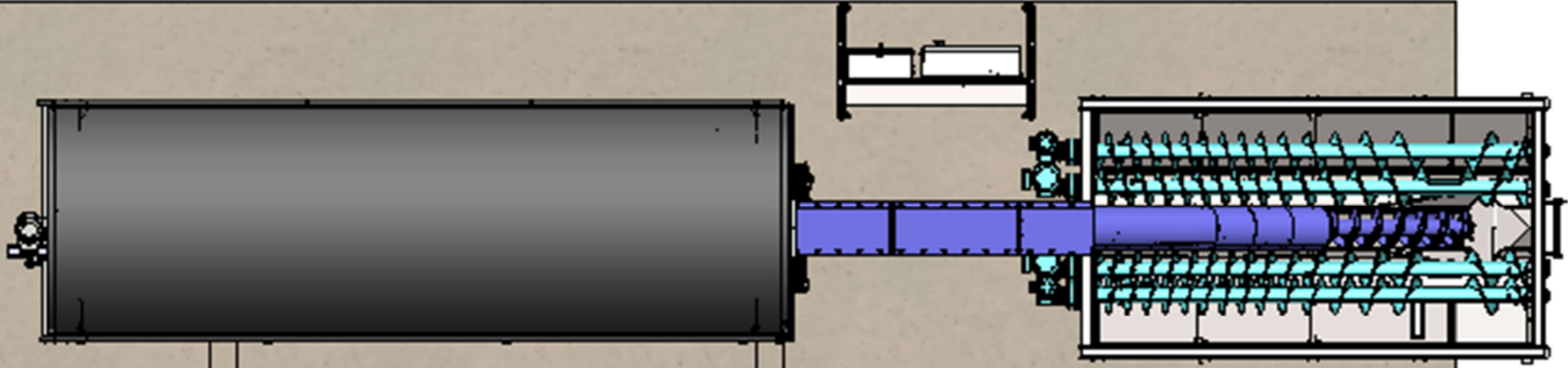

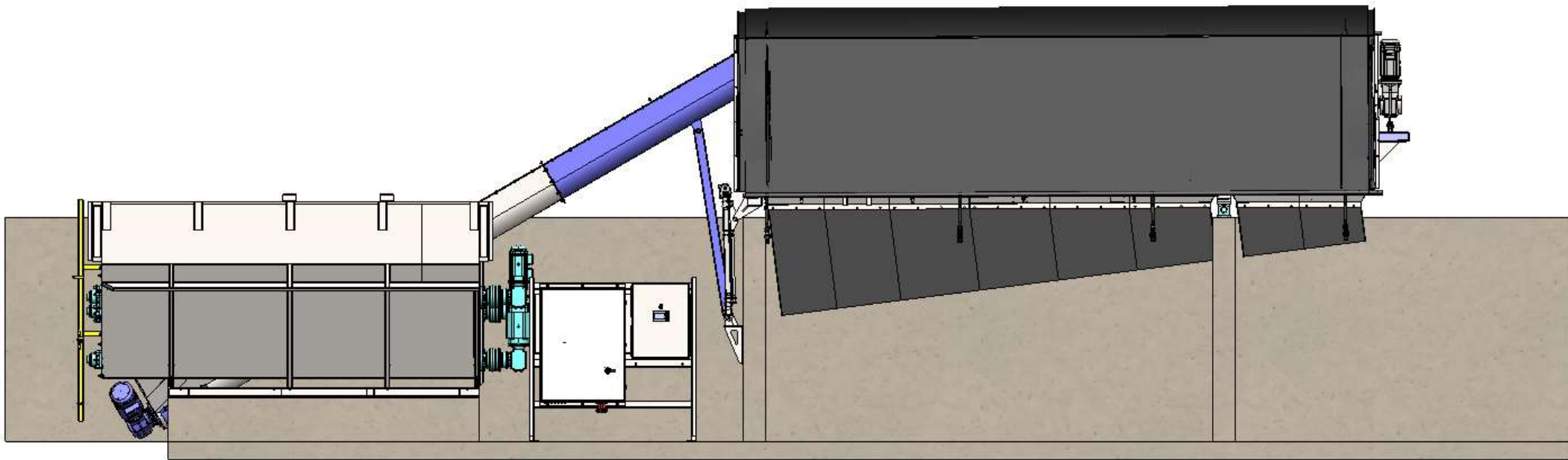

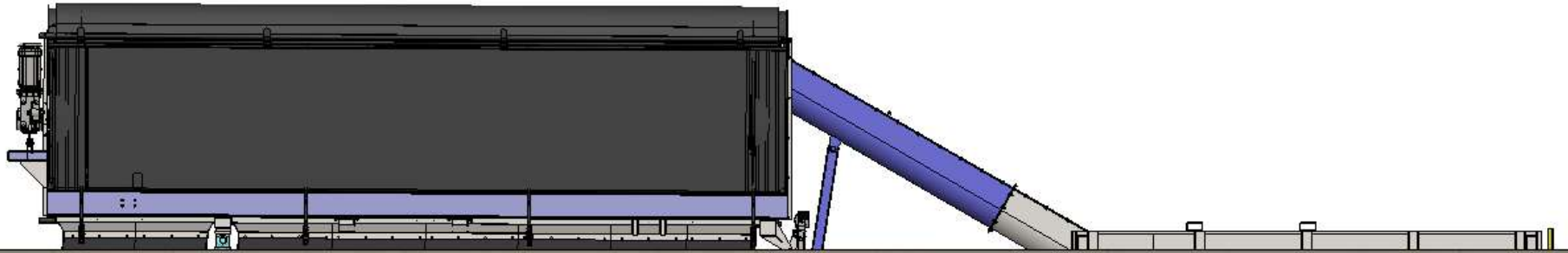

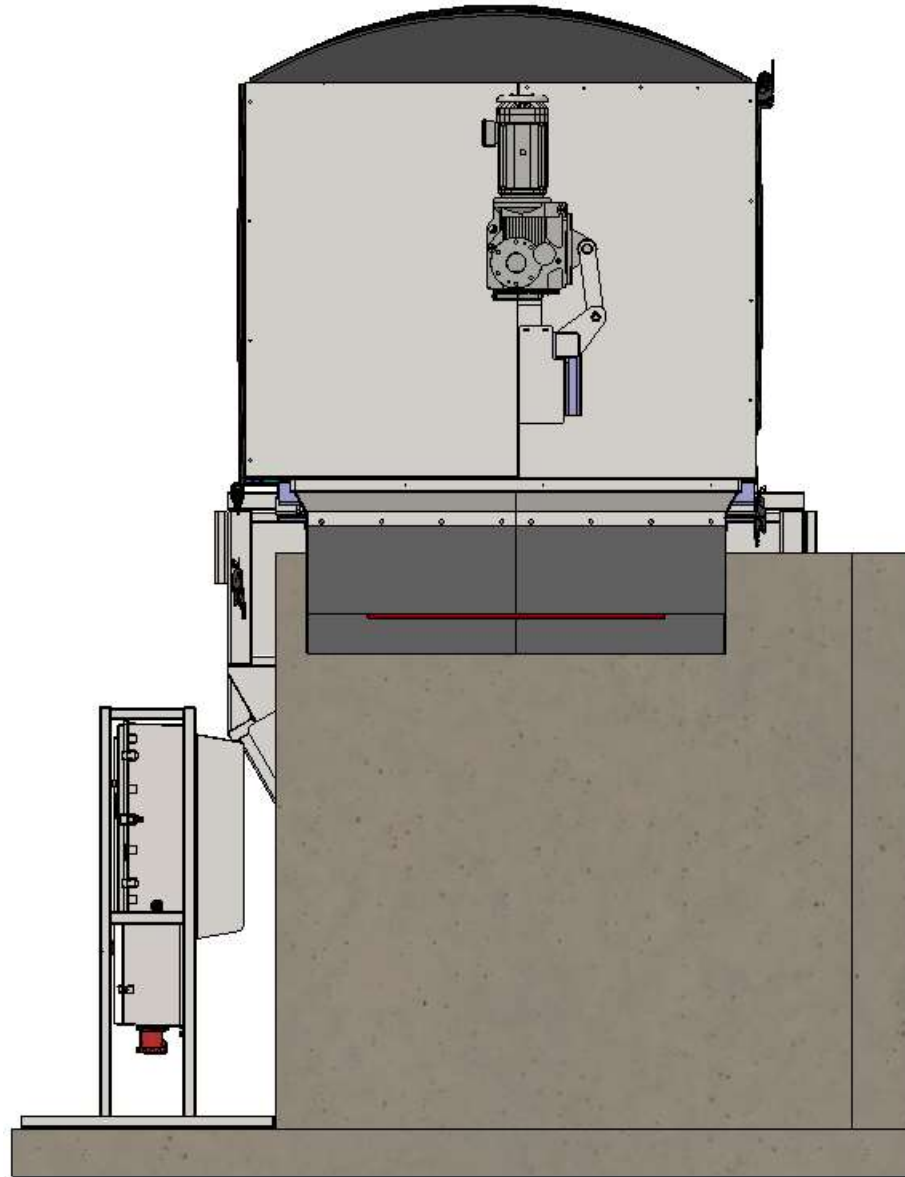

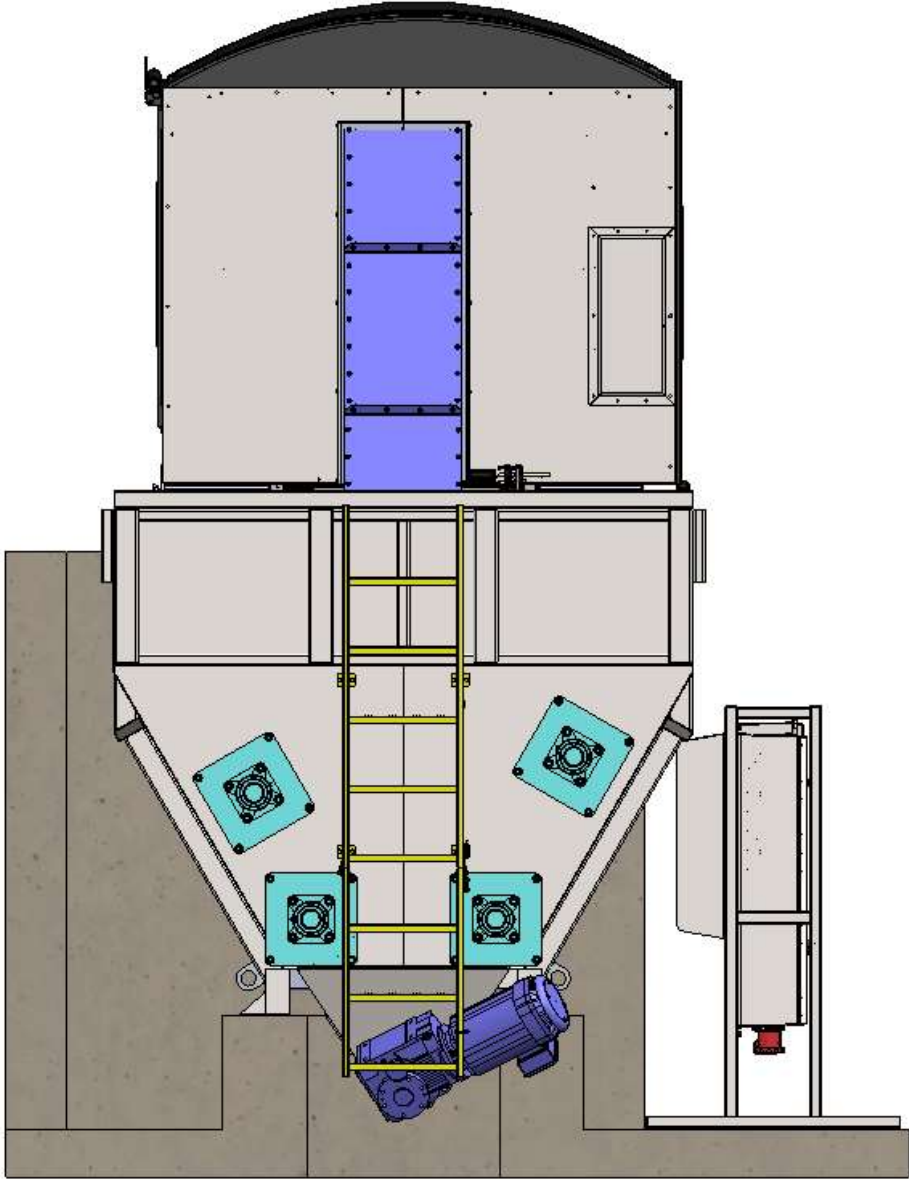

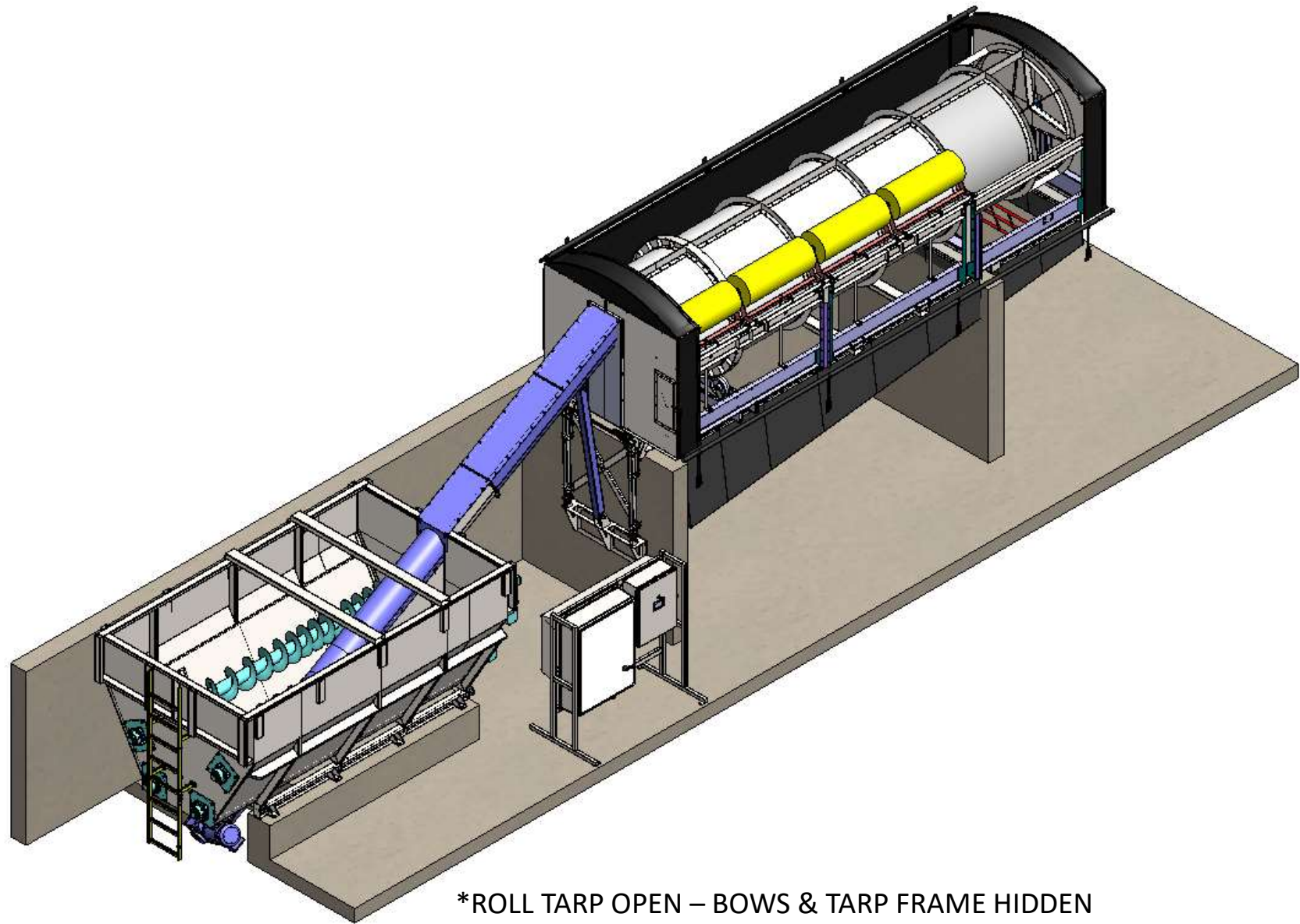

*ROLL TARP OPEN – BOWS & TARP FRAME HIDDEN

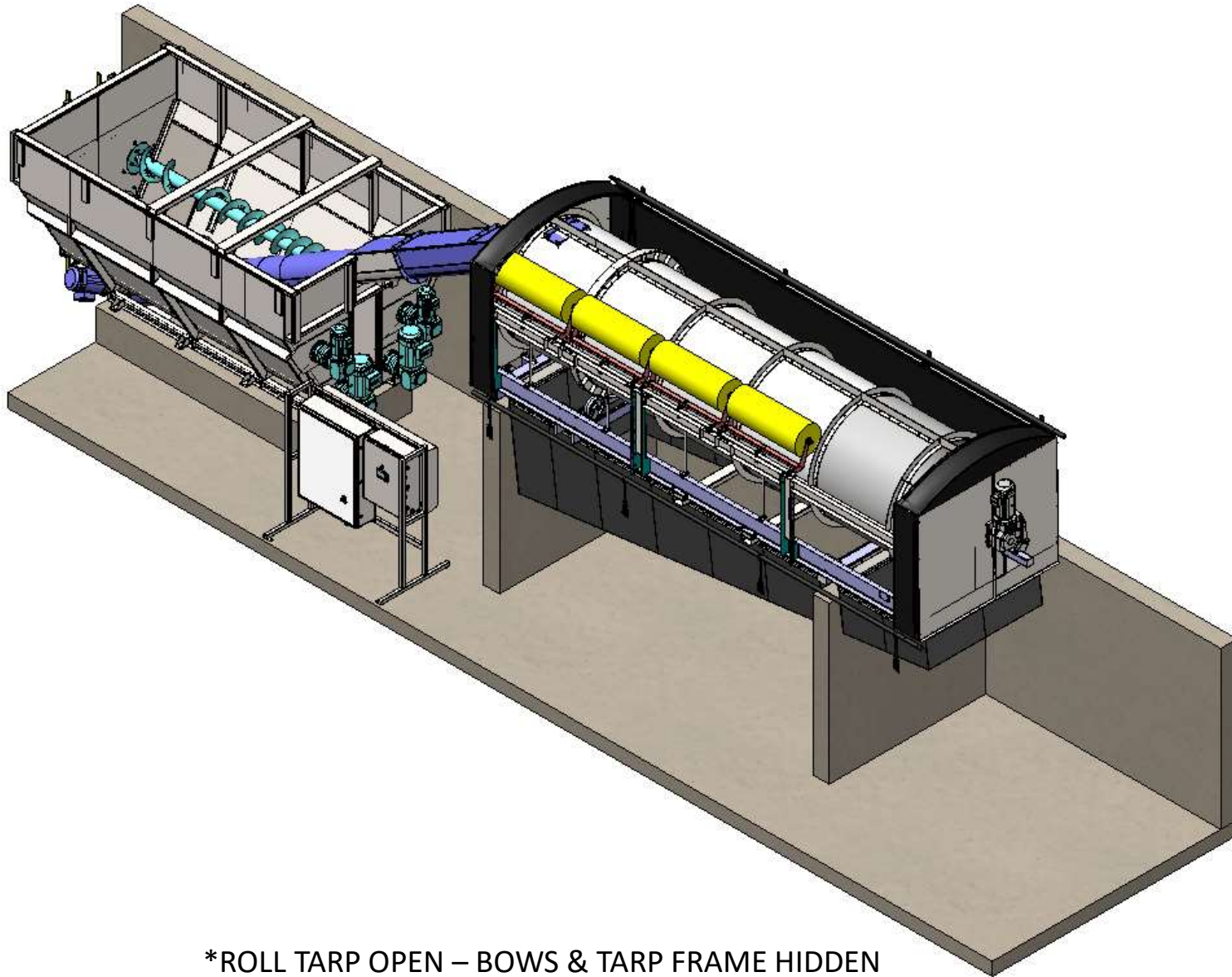

*ROLL TARP OPEN – BOWS & TARP FRAME HIDDEN

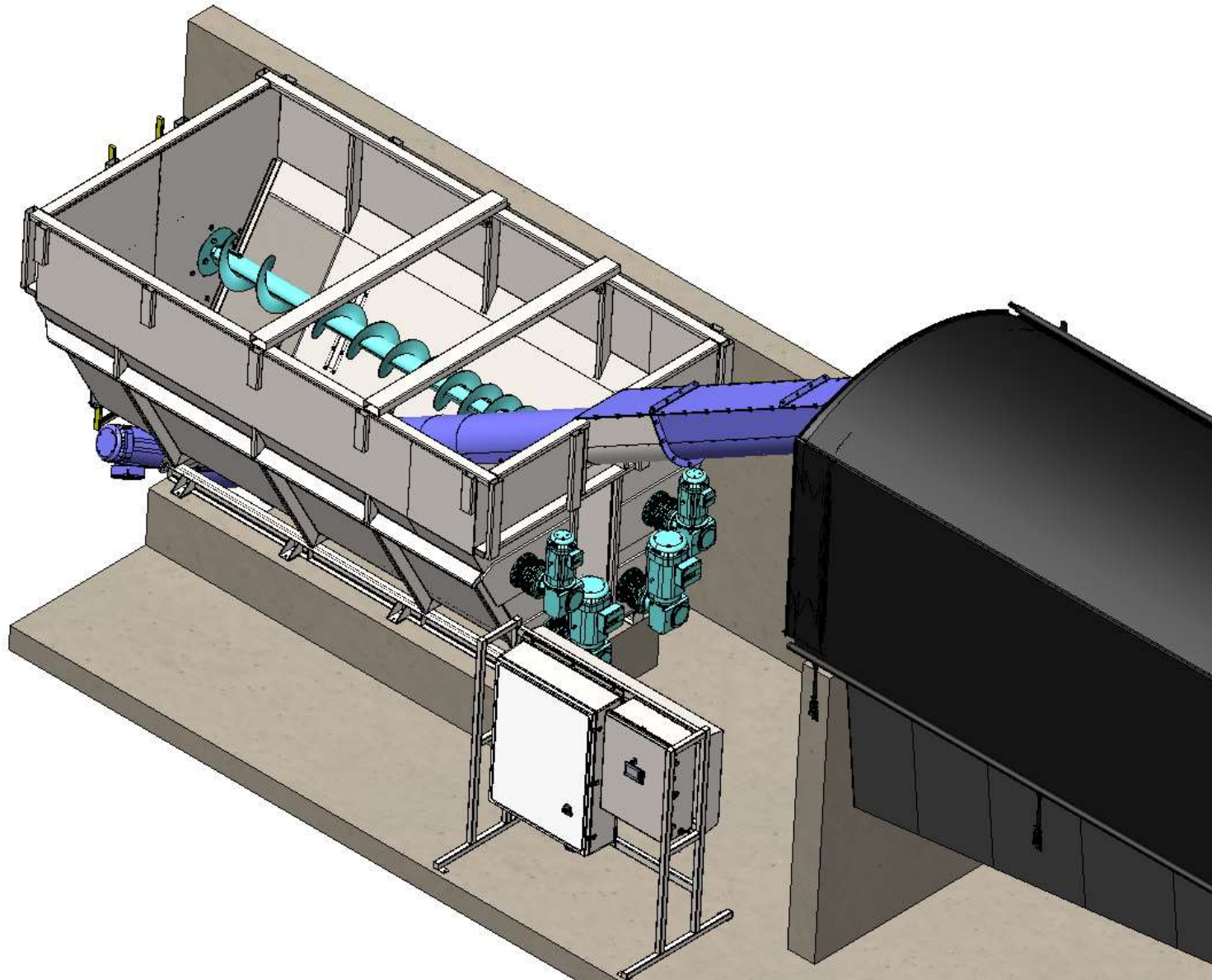

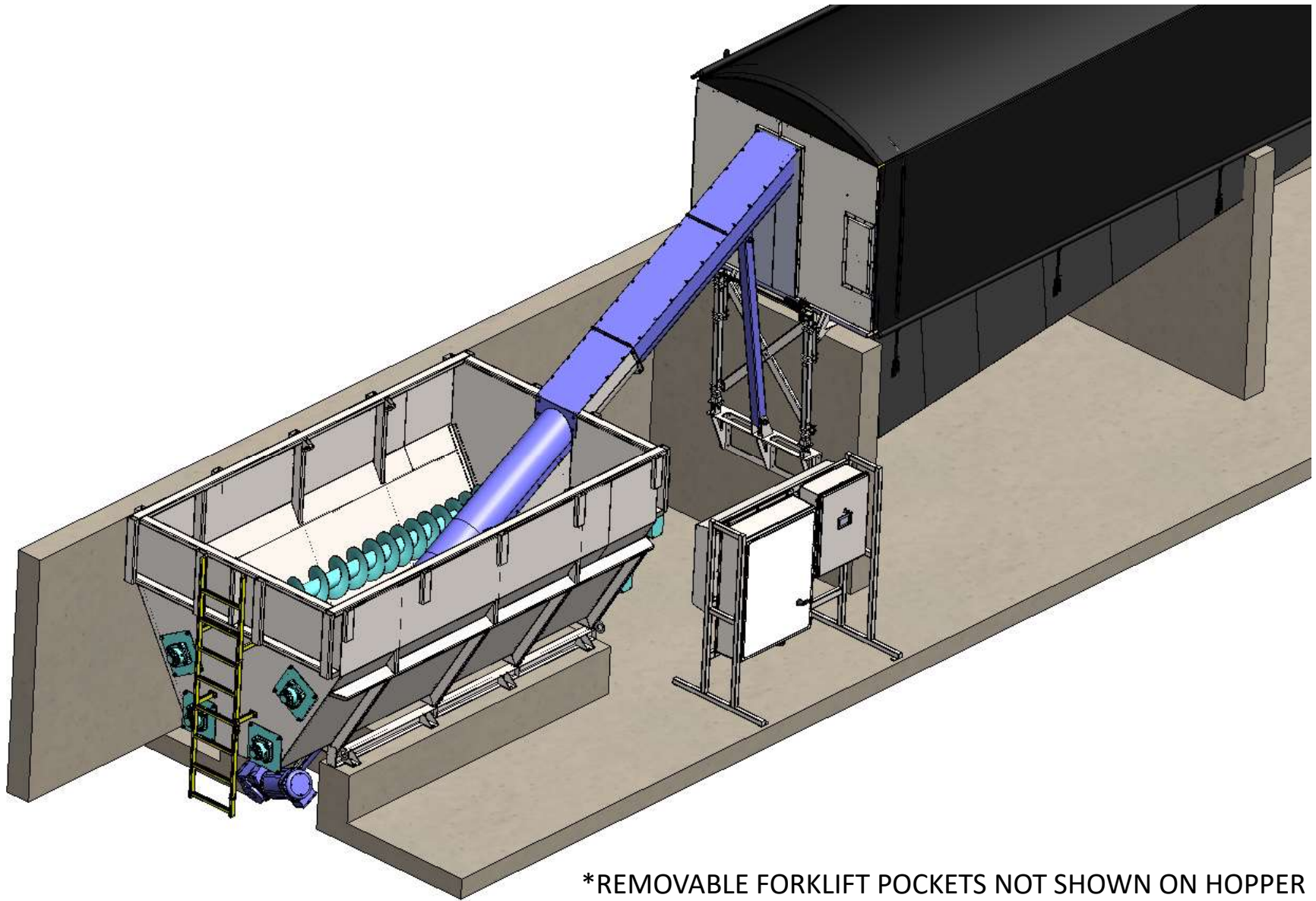

*REMOVABLE FORKLIFT POCKETS NOT SHOWN ON HOPPER

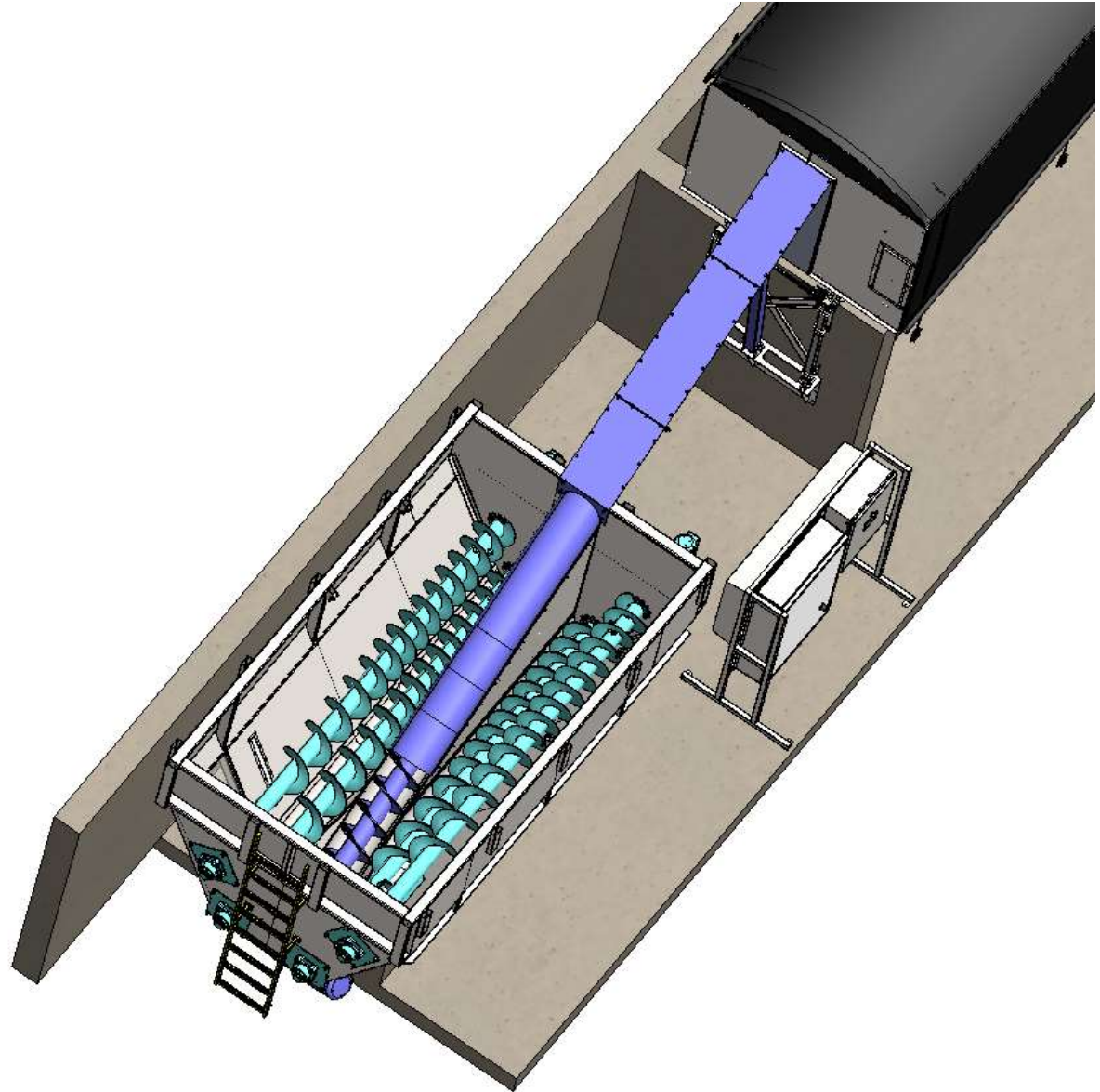

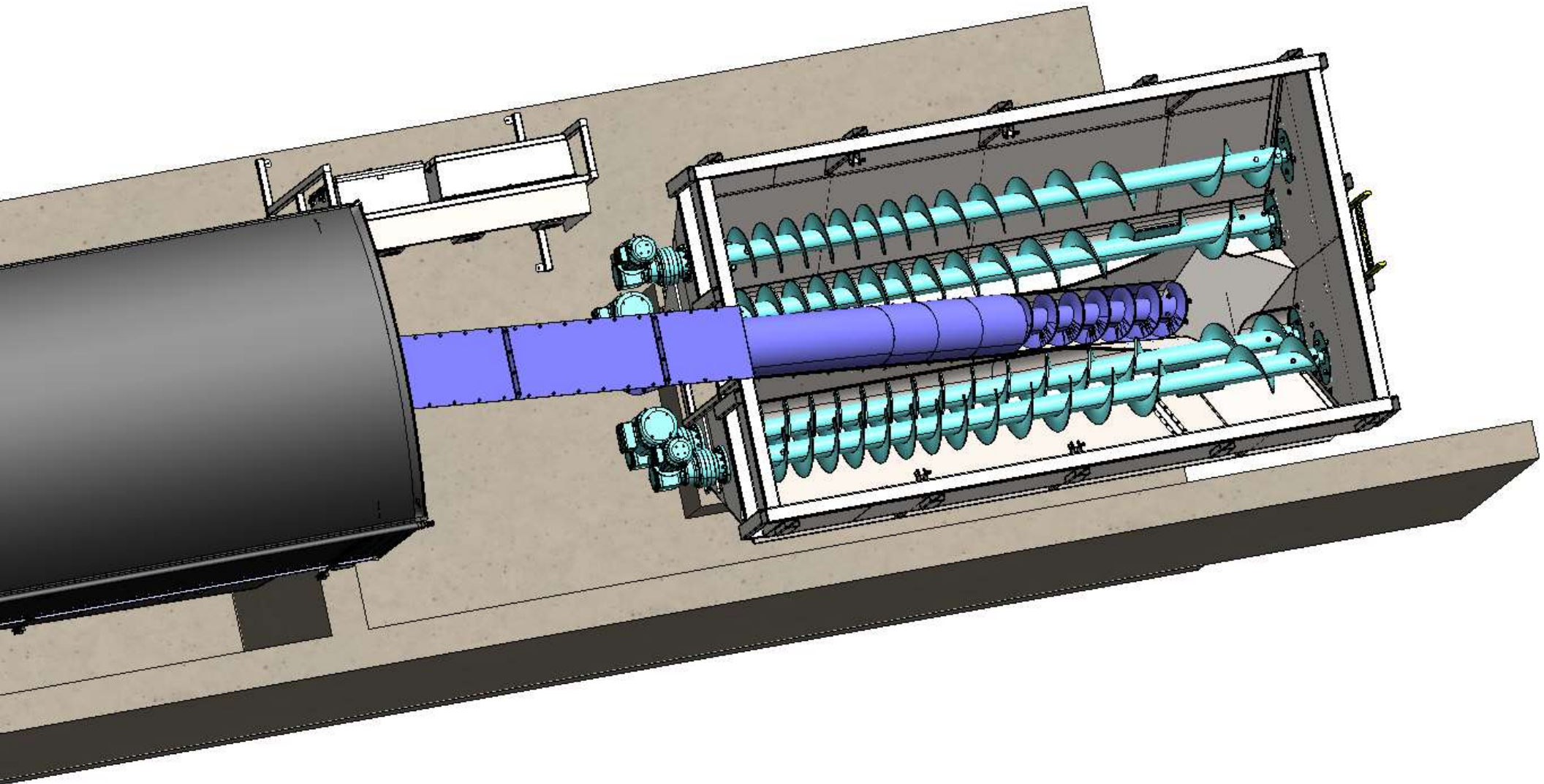

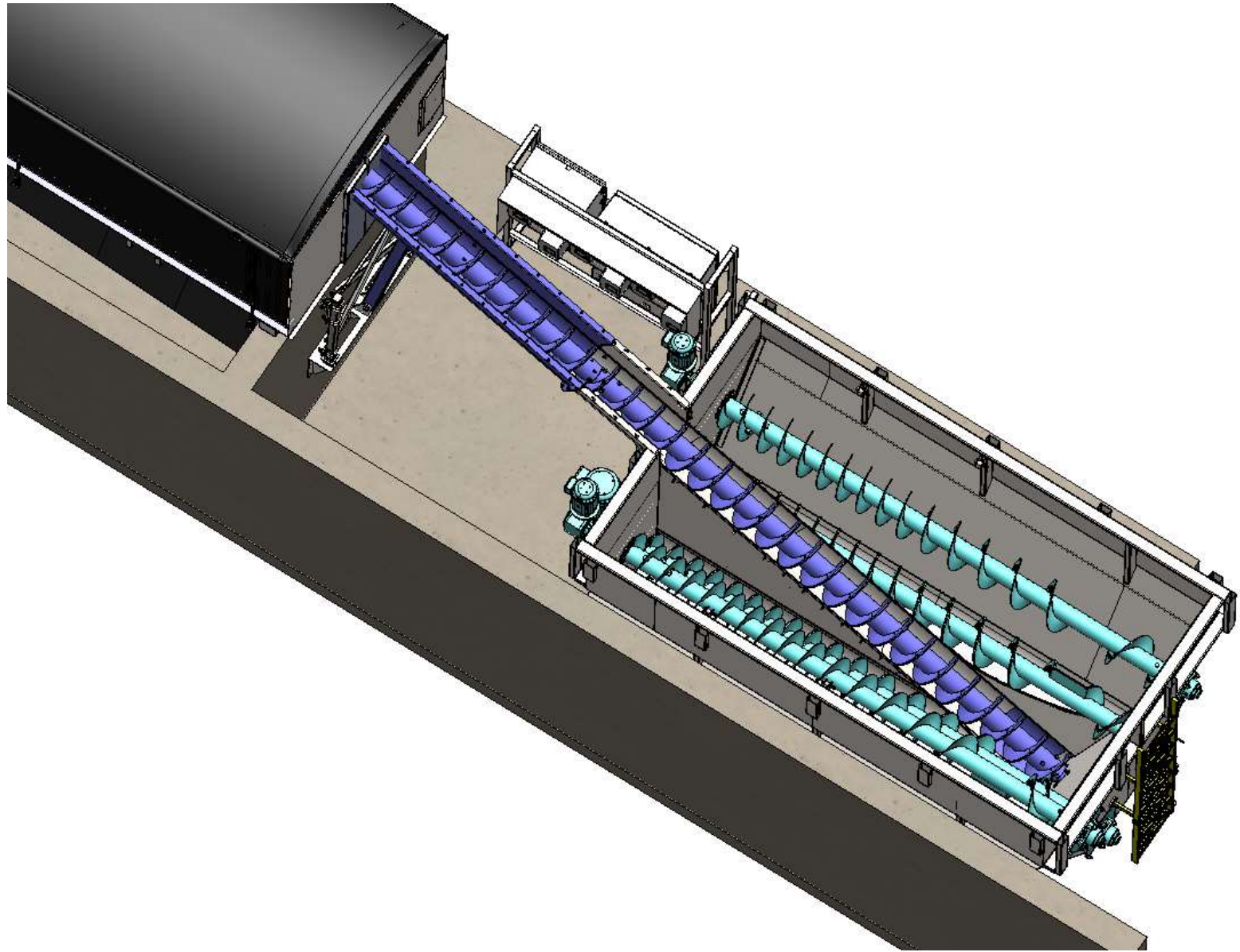

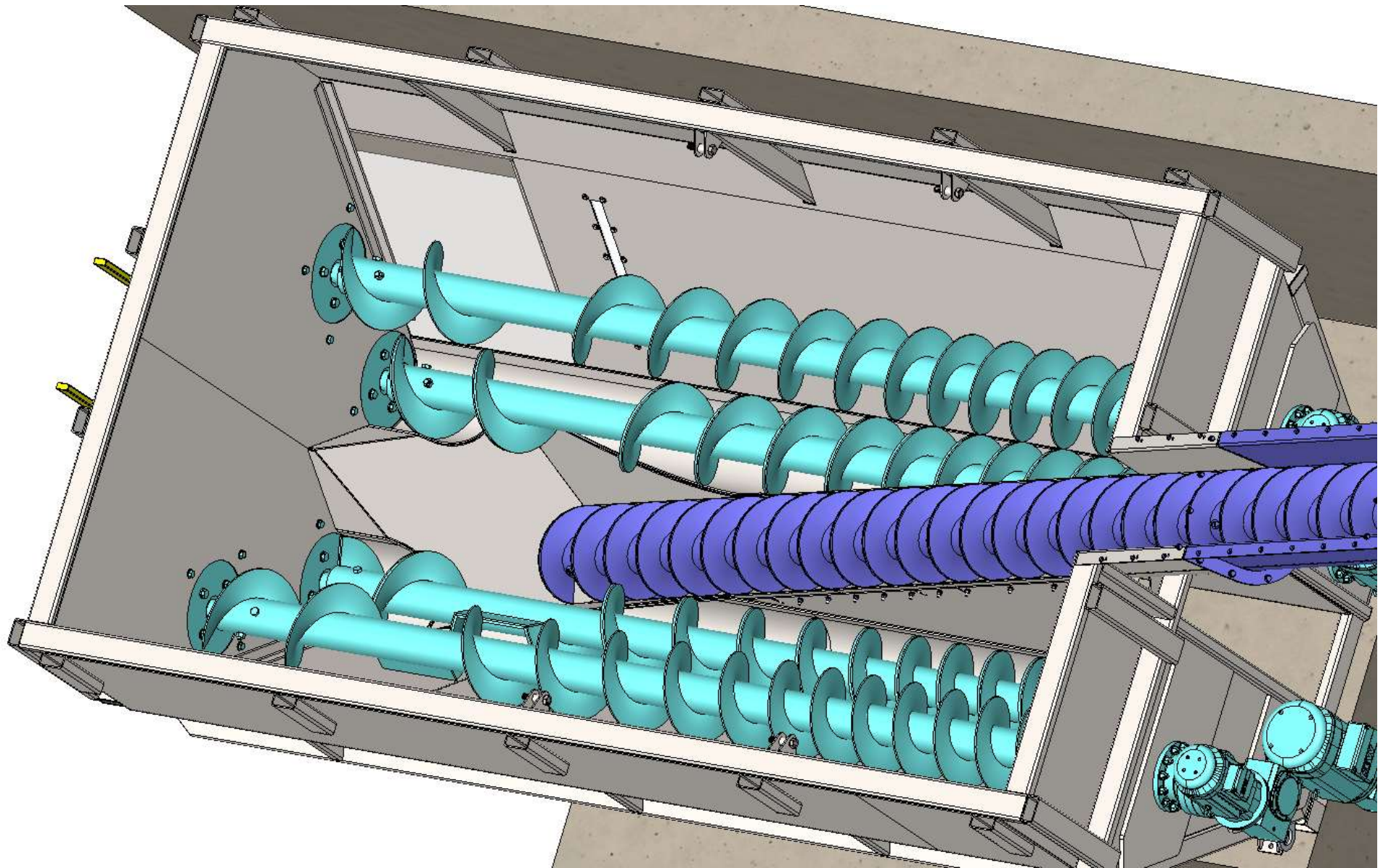

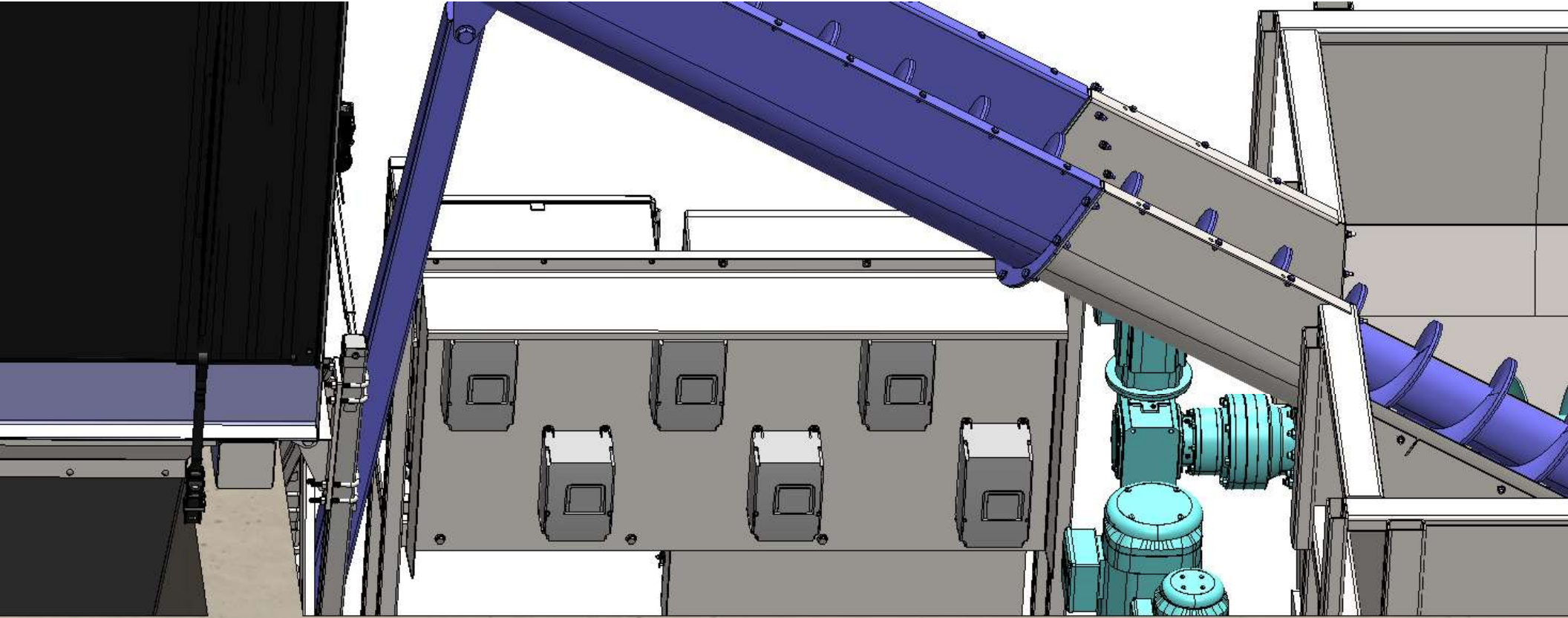

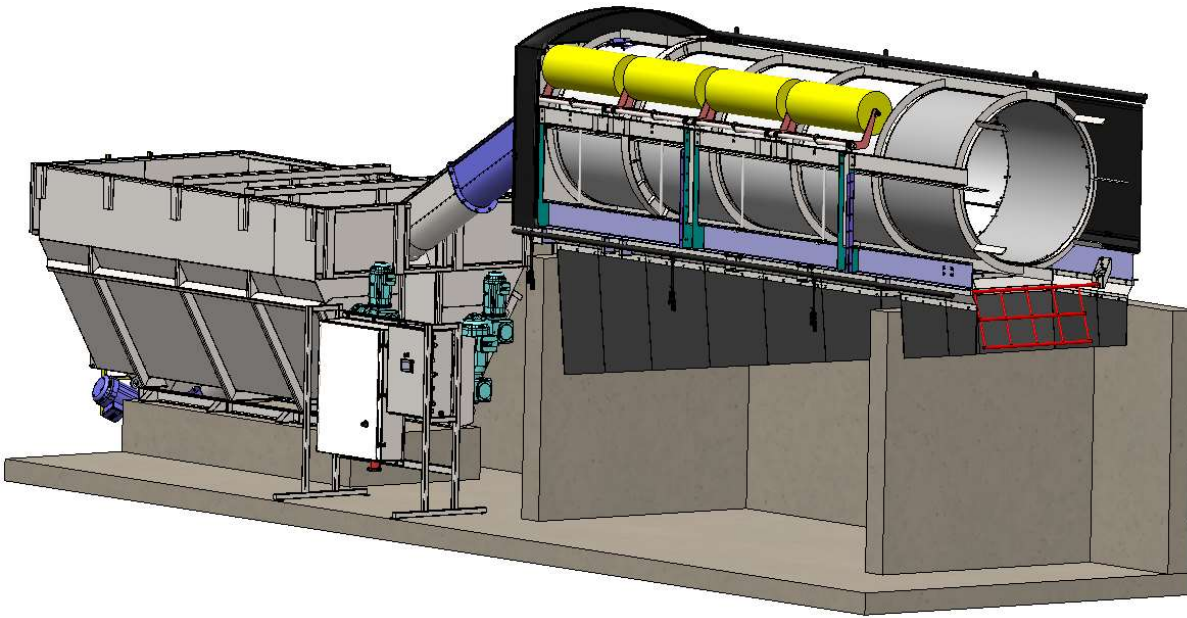

TROMMEL OUTLET SECTION VIEW

*ROLL TARP OPEN – BOWS & TARP FRAME HIDDEN

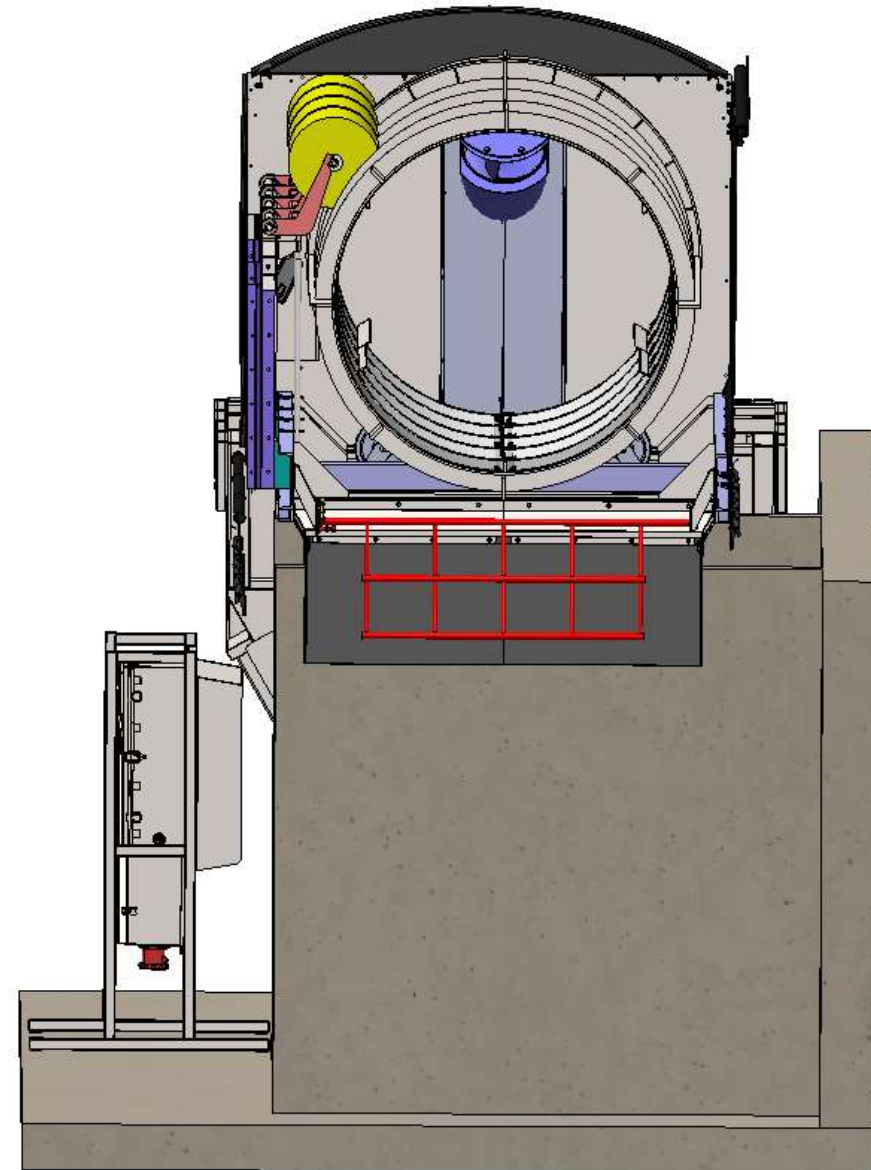

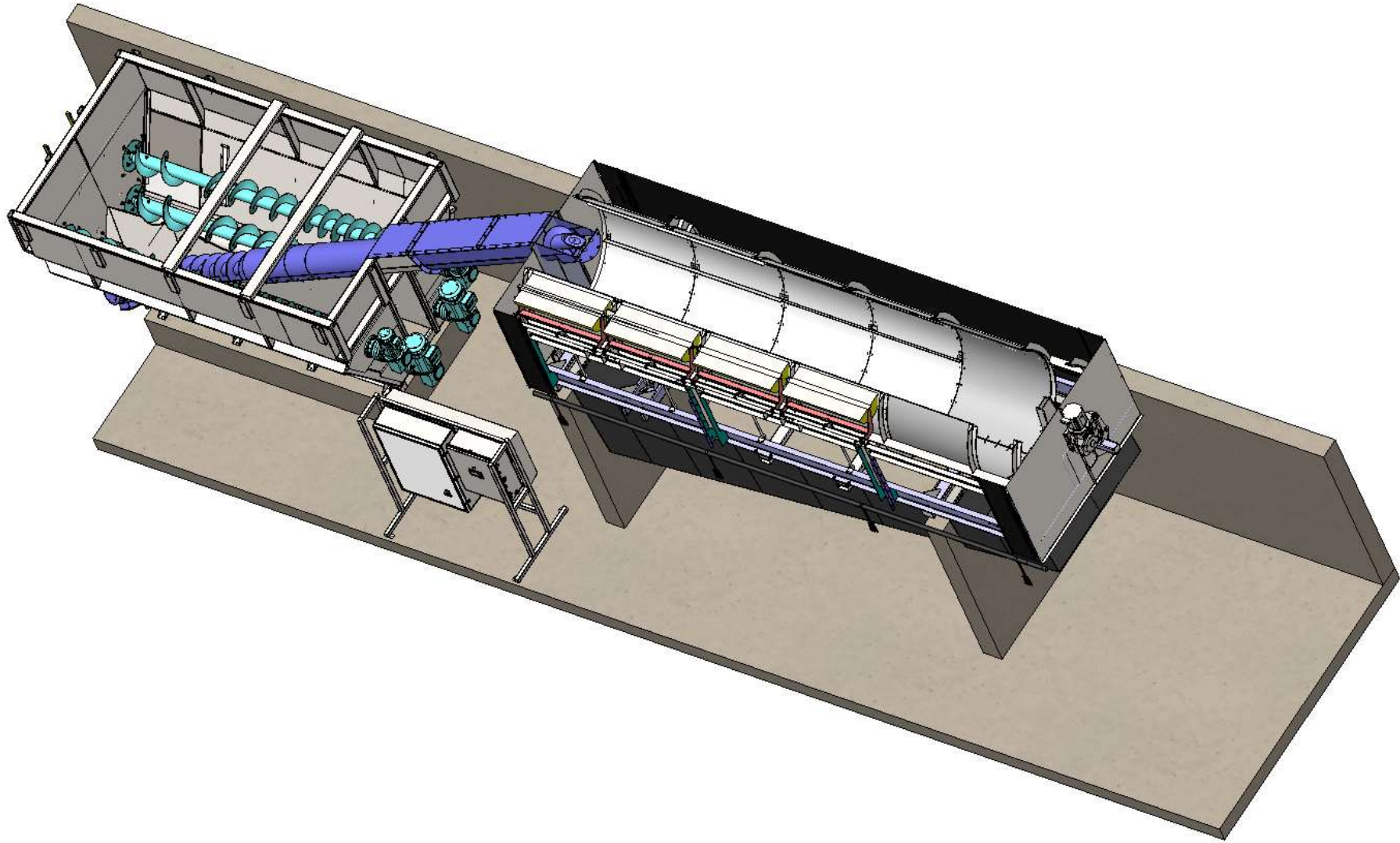

TROMMEL TOP SECTION VIEW
*ROLL TARP OPEN – BOWS & TARP FRAME HIDDEN

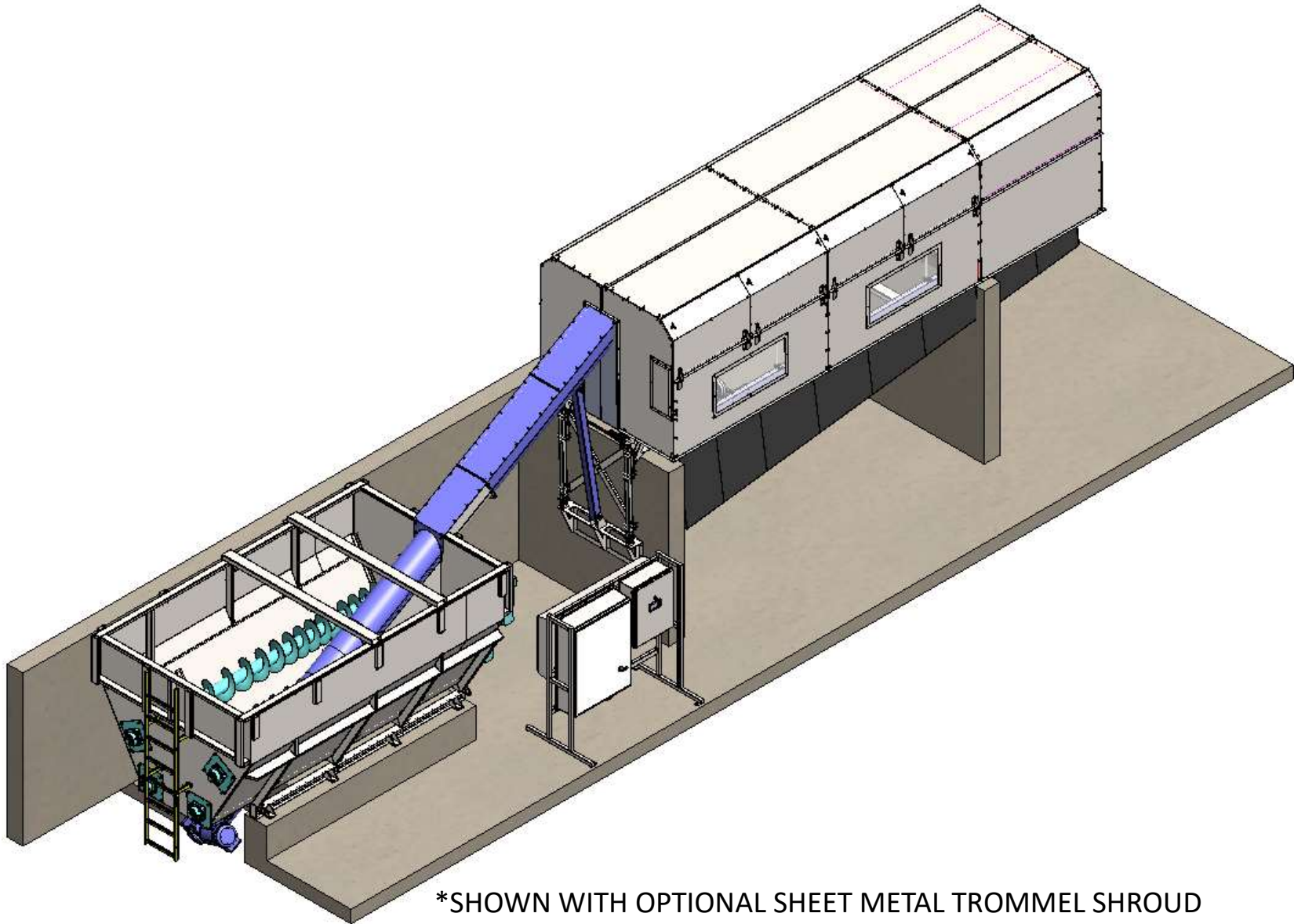

*SHOWN WITH OPTIONAL SHEET METAL TROMMEL SHROUD

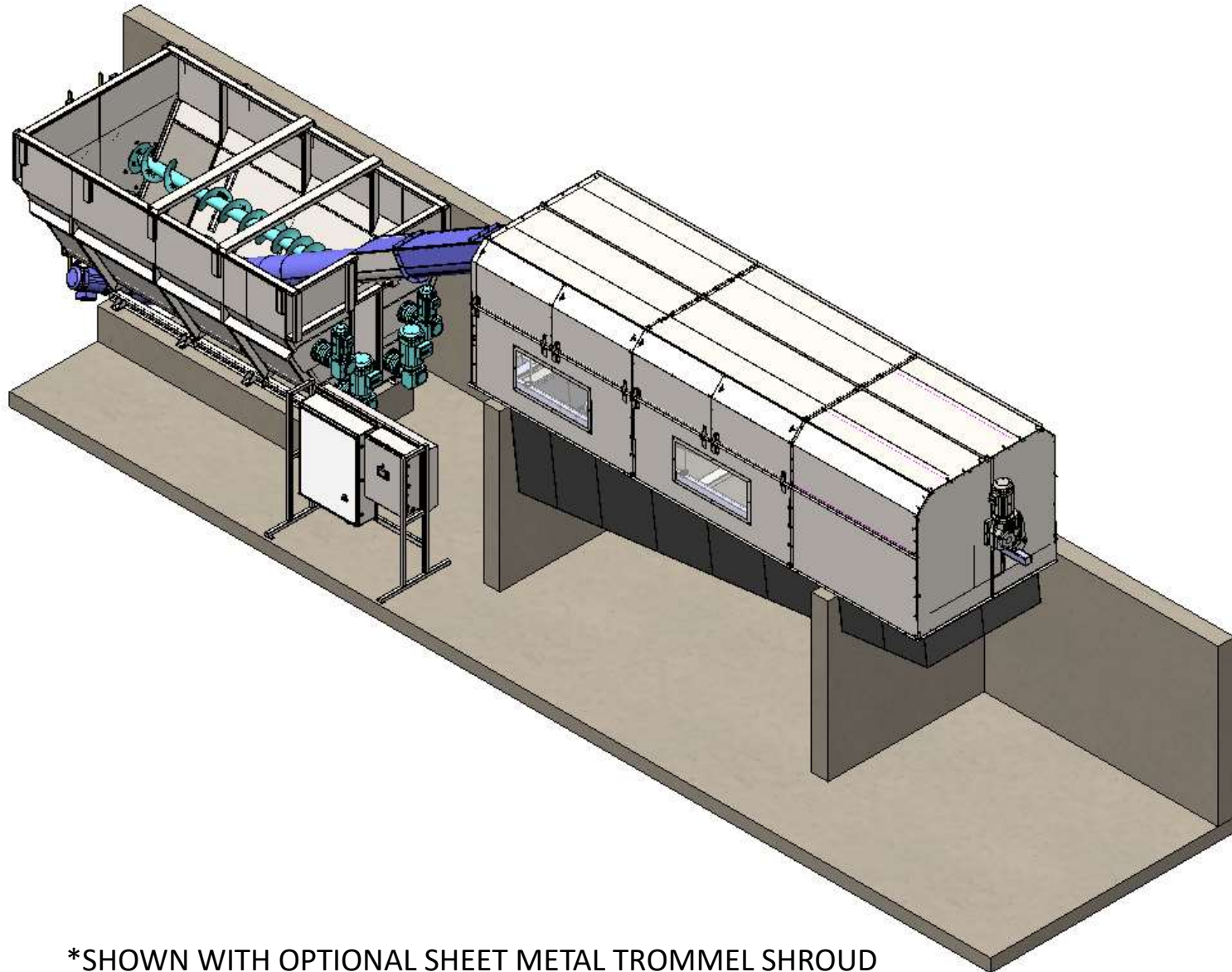

*SHOWN WITH OPTIONAL SHEET METAL TROMMEL SHROUD

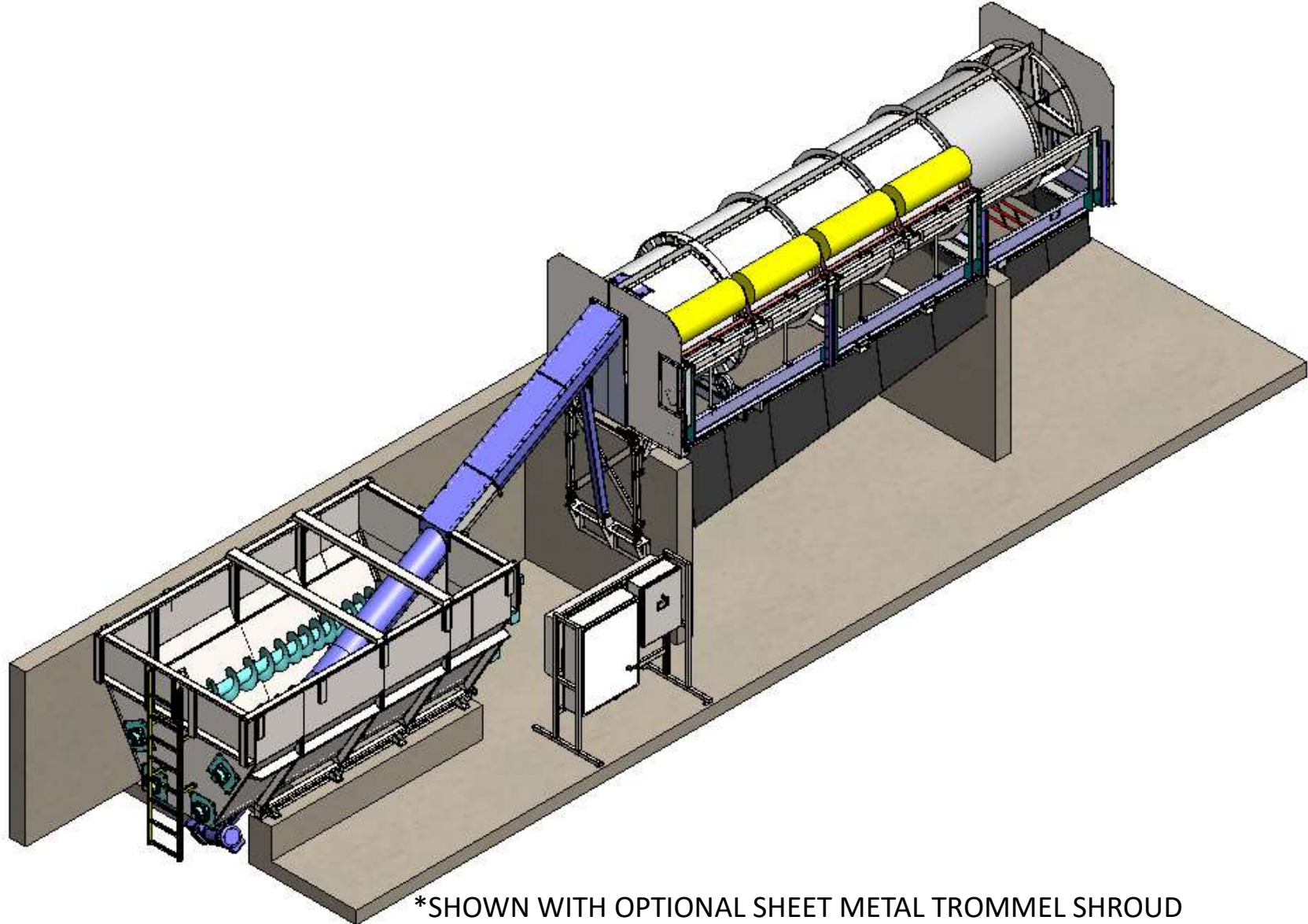

*SHOWN WITH OPTIONAL SHEET METAL TROMMEL SHROUD

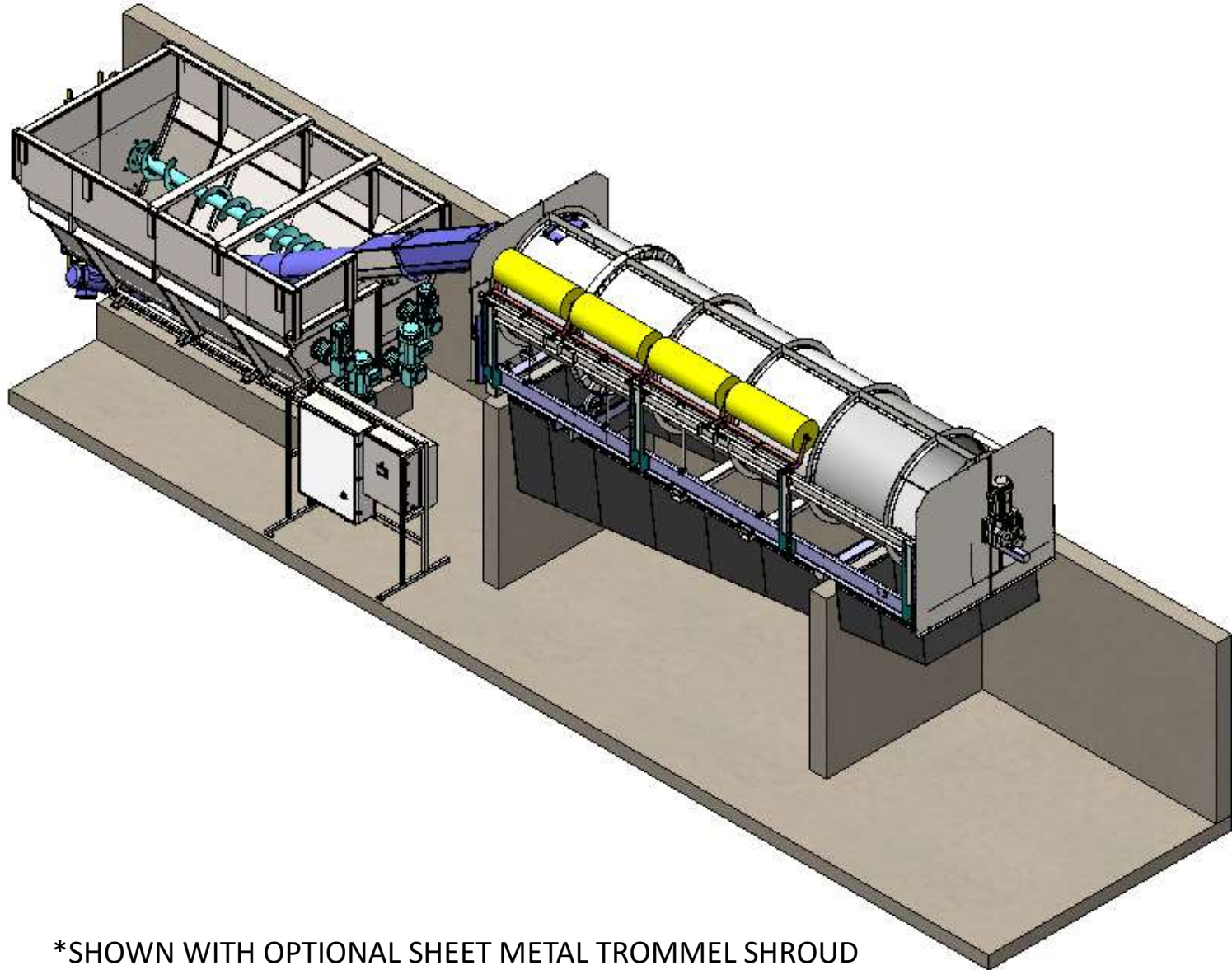

*SHOWN WITH OPTIONAL SHEET METAL TROMMEL SHROUD